

HDZero Video Transmitters



Whoop



Whoop Lite

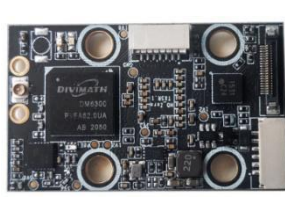

Race V1

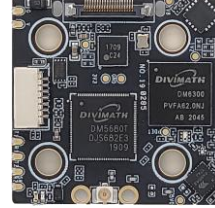

Race V2



Freestyle

What is HDZero?

PUSH YOUR SKILLS TO THE LIMIT

HDZero offers industry-leading low latency, giving you more time to react and the best possible chance of hitting that next gap. With its smooth, consistent FPV video feed, you'll experience the same locked-in feeling you get with analog video—but with the clarity of HD.

MAKE IT AN EVENT

HDZero supports the standard 5.8ghz video channels, meaning you can have up to 8 simultaneous pilots flying either full-quality HDZero or analog video. When you're ready to take a break and spectate, you can tune in to any channel and view the pilot's feed with no loss of quality, giving you the same feeling of being in the air yourself.

UPGRADE YOUR FLEET

From 1S whoops to long-range wings, HDZero offers a variety of VTX and camera options to suit every build. You may even be able to use the gear you already have—the HDZero receiver will work with any FPV goggle with an HDMI input. HDZero can grow with your needs and fit perfectly into your preferred FPV craft.

RAPIDLY EVOLVING SYSTEM

HDZero is rapidly evolving. Please always use the latest firmware that is located at www.hd-zero.com/document.

Contents

What is HDZero?	1
HDZero VTXes	3
HDZero Whoop Video Transmitter	4
HDZero Whoop Lite Video Transmitter	5
HDZero Race V1 Video Transmitter	6
HDZero Race V2 Video Transmitter	7
HDZero Freestyle Video Transmitter	8
HDZero VTX Installation Guide	10
HDZero Firmware Update Guide	11
VTX update Guide	12
VRX update Guide	12
Steps to update HDZero VRX	12
Steps to update Shark Byte VRX	12
Steps to flush VRX in case of not booting up	12
Setup and Getting Started	14
OSD Setup	14
1. Prerequisite	14
2. Update firmware VTX and VRX	14
3. Solder/Connect VTX UART to an available UART on your FC board	14
4. Flight controller Configuration (Use Betaflight as example)	14
5. Restart/Connect Flight controller Configuration (Use Betaflight as example)	15
Stick Movement	16
Using VTX Menu (Applicable to all HDZero VTXes)	17
Using SmartAudio (Not applicable to HDZero Whoop VTX)	18
Help and Troubleshooting	20
FAQ	20
Trouble Shooting	20

HDZero VTXes

	Whoop	Whoop Lite	Race V1	Race V2	Freestyle
Dimension	32x32	32x32	27x45	34x34	40x40
Mounting Pattern	25.5x25.5 M2	25.5x25.5 M2 (Soft)	20x20 M4 (Soft)	20x20 M4 (Soft)	30x30 M3 (Soft)
Weight	5.3grams	4.5grams	7 grams	6 grams	28grams
Power Input	2S-6S	1S-3S	2S-6S	2S-6S	2S-6S
Power Consumption	5~6W	5-6W	5~6W	5~6W	6~15W
RF Power Output	25mW,200mW	25mW,200mW	25mW,200mW	25mW,200mW	25mW,200mW (500mW, 1W if with HAM license)
Secured U.FL	No	Yes	Yes	Yes	Yes
Antenna Included	Not included	Not included	Not included	Not included	Polarized (RHCP)
Smart Audio	No	Yes	Yes	Yes	Yes
MSP Display Port	Yes	Yes	Yes	Yes	Yes
Application	Whoop	Tiny Whoop	Race	Race	Freestyle

HDZero Whoop Video Transmitter

The HDZero Whoop VTX is a digital HD 720p 60fps video transmitter capable of delivering up to 200mw on 5.8GHz.

The power input range is 7V – 26V (2S – 6S). Though the Whoop VTX has an integrated surge protection circuit, a large capacitor (450+uF) parallel with battery leads is **mandatory** to smooth the power supply of the whole quad.

It is highly recommended to use a BEC (8-12V) to power this VTX. The maximum 1A current will be drawn from BEC.

This VTX is designed for low-speed whoop application. It is vulnerable to be damaged by crash due to: (1) the UFL connector is easily peeled off due to no antenna retention, and (2) it doesn't support soft mounting. Though the VTX can be mounted on a racing and other high-speed quad, it is highly recommended to consider HDZero Race (V1 or V2) for such cases.

This VTX does not support Smart Audio.

1	Power/UART cable
2	FW Update Connector
3	UART (3.3V)
4	MIPI Connector
5	Power IN (7-26V)
6	Power LED (red)
7	u.FL Antenna Connector
8	Status LED (blue)

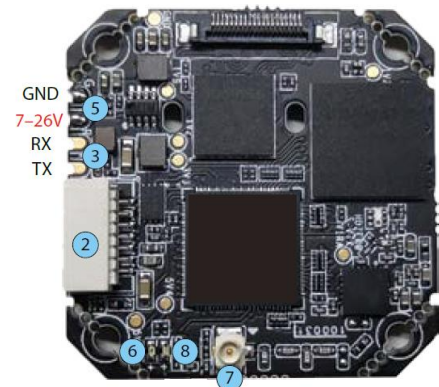
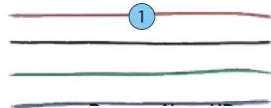

HDZero Whoop Lite Video Transmitter

The HDZero Whoop lite VTX is a digital HD 720p 60fps video transmitter capable of delivering up to 200mw on 5.8GHz.

The power input range is 2.8V – 13V (1S-3S).

- When it is powered by a 5V pad of FC/BEC, make sure that 5V has 1.5A current output.
- When it is powered by an 1S battery directly, note that a rapid throttle up may cause voltage drop below to 2.8V instantly, and that will cause video drop.
- There is no need for an external capacitor when it connects with FC/BEC or 1S battery. However, it is strongly suggested to put on capacitor when powered by a 3S battery.

This VTX has protection cases mounted on both sides. These metal cases are grounded, and to provide protection from crash. They can be removed for tiny whoop quad which cares about every added gram.

This VTX includes M3/M2 gummies for soft mounting, and zip ties for antenna retention. Though the VTX can be mounted on a racing and other high-speed quad, it is highly recommended to consider HDZero Race (V1 or V2) for such cases.

1	MIPI Connector
2	Status LEDs
3	Power/UART/SA solder pads
4	u.FL Connector
5	Protection Case
6	Protection case clipper

Solder pads:

G	Ground
V	2.8V -13V
RX	FC.TX
TX	FC.RX
SA	FC.SA (TX), Optional

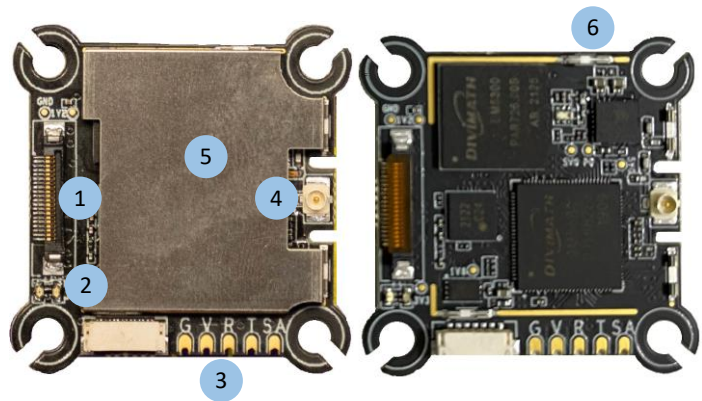

HDZero Race V1 Video Transmitter

The HDZero Race VTX is a digital HD 720p 60fps video transmitter capable of delivering up to 200mw on 5.8GHz.

The power input range is 7V – 26V (2S – 6S). Though the Race VTX has an integrated surge protection circuit, a large capacitor (450+uF) parallel with battery leads is **mandatory** to smooth the power supply of the whole quad.

1	Power/UART Connector
2	FW Update Connector
3	MIPI Connector
4	u.FL Antenna Connector
5	u.FL Antenna Retention Holes
6	Power on LED (red)
7	Status LED (blue)
8	Mounting Holes (20x20 M4)
9	Zip Ties (4x)
10	u.FL Antenna Retention Screws(4x)/Nut(4x)/Plate
11	Rubber Grommet (M4 to M3 4x)
12	Power/UART harness (20cm) and a PH2.0 connector (6P)

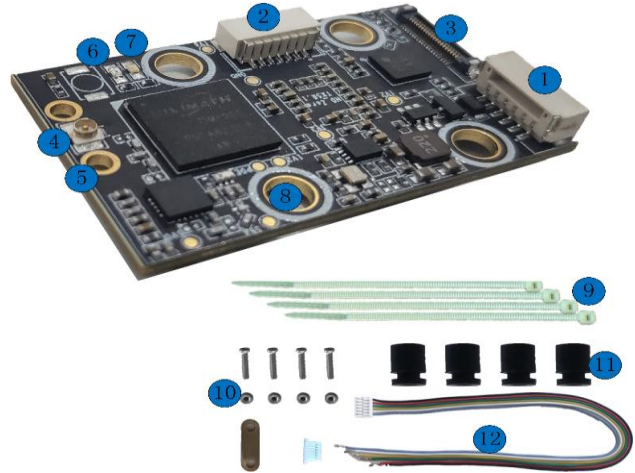

Power/UART Connector	Cable Color	Connected with
Ground	Black	Ground
Power	7-26V (2S-6S)	Power
T1	Green	FC.RX
R1	Yellow	FC.TX
T2	White	DO NOT CONNECT
R2/SA	Gray	FC.SA (TX)

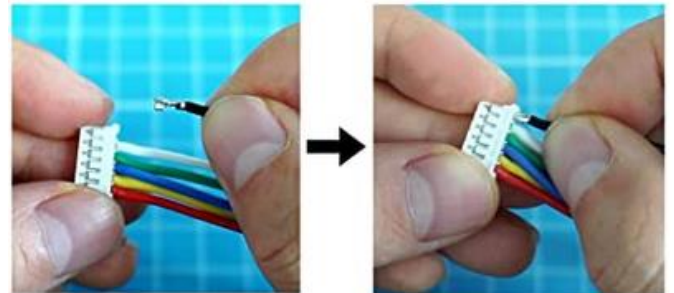

Connection between Race V1 VTX and FC

There are 3 methods to connect the VTX and flight controller:

- Plug the included harness, cut the cables to appropriate length, and solder them on FC
- Use solder pads on the back of the connector
- For FCs having BEC and UART connector, install harness to the included PH2.0 connector (Shown above), and connect the harness with FC without any soldering.

Warning: Check that pinout matches the FC pinout before installing to be safe if plugging directly.

Mounting an u.FL antenna or pigtail

There are 2 methods to mount antenna on VTX:

- Use included retention screws, nuts and plate;
- Use included zip-ties.

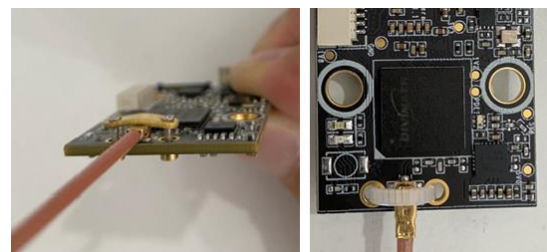

HDZero Race V2 Video Transmitter

The HDZero Race VTX is a digital HD 720p 60fps video transmitter capable of delivering up to 200mw on 5.8GHz. It works with the Shark Byte RX5.1 goggle module to transmit video, and with a remote controller to wirelessly control the parameters for the transmitter and camera.

The power input range is 7V – 26V (2S – 6S). Though the Race VTX has an integrated surge protection circuit, a large capacitor (450+uF) parallel with battery leads is **mandatory** to smooth the power supply of the whole quad.

1	Power In (G=Ground, V=7-26V)
2	T1/R1 UART Connection to FC
3	T2, Reserved, R2/SA, SA Pin
4	u.FL Antenna Connector
5	u.FL Antenna Retention Holes
6	MIPI connector
7	MIPI connector retention Holes
8	Firmware Update Connector
9	Power on LED (red)
10	Status LED (blue)
11	u.FL Antenna Retention Screws/Nut/Plate
12	Rubber Grommet (M4 to M3), 1mm O-Ring
13	Zip ties
14	Connecting wire
15	20x20 M4 mounting holes

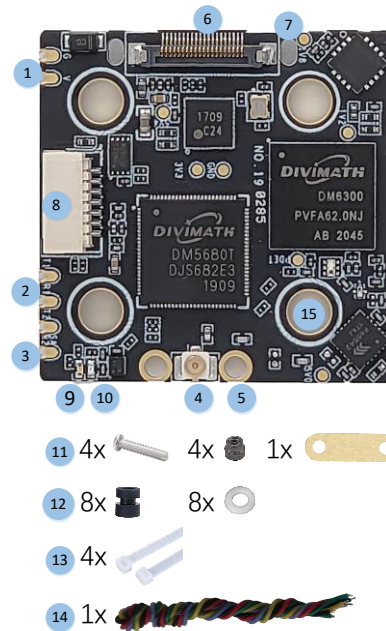

Mounting a u.FL antenna or pigtail

There are 2 methods to mount the antenna on VTX:

- Use included retention screws, nuts and plate;
- Use included zip-ties.

Connecting MIPI cable

Use the included zip-tie to secure MIPI cable and protect MIPI connector.

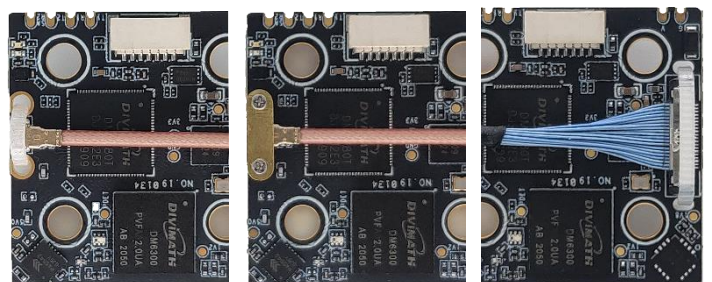

Notes:

- SA Pin is needed to connect with FC only when you decide to let FC fully controls VTX's freq and outputting power. Read Using SmartAudio section to setup VTX table, and etc. Note that VTX Menu is not available for this case.
- If SA pin is not connected, VTX will use its own logic to control freq and outputting power. It has VTX Menu to setup these parameters.

HDZero Freestyle Video Transmitter

The HDZero Freestyle VTX offers unprecedented range and performance for the HDZero 5.8GHz digital FPV system. With its high maximum output power and robust construction, this VTX is perfect for freestyle and long-range builds.



With a tested maximum range of more than 18 miles, the Freestyle VTX will transmit a digital FPV feed as far as you're willing to fly. Not interested in long range? You'll also see better performance in urban environments and around obstacles, with none of the color noise or multipath interference issues of analog video.

- | | |
|----|------------------------|
| 1 | Secured MIPI Connector |
| 2 | Keypad Connector |
| 3 | M3 Mounting Hole |
| 4 | Secured U.FL Connector |
| 5 | FW Update Connector |
| 6 | Power/UART Connector |
| 7* | BEC Power in (2S-6S) |
| 8* | BEC Power Out Pad |
| 9 | RHCP Antenna |
| 10 | Power/UART Harness |

*: BEC is included for first Batch only.

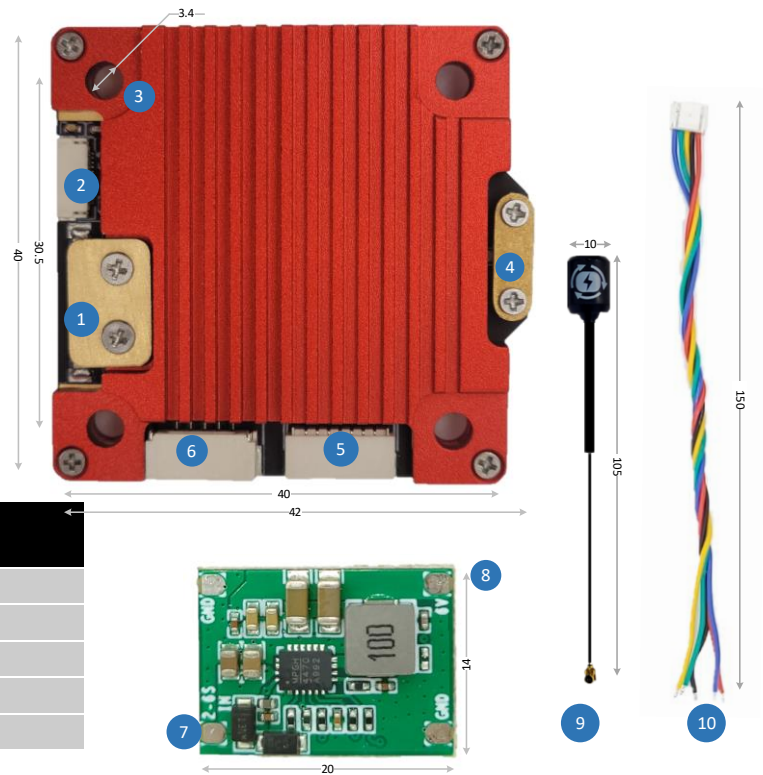

Power/UART Connector	Cable Color	Connected with
Ground	Black	Ground
Power	Red	Power*
RX	Green	FC.TX
TX	Yellow	FC.RX
SA	Blue	FC.SA (TX), Optional

*: The 1st batch supports 4S MAX.

The 1st batch of Freestyle VTX, supports 2S-4S, A BEC supporting 2S-6S is included.
The 2nd batch and later, supports 2S-6S, and the BEC is *not* included.

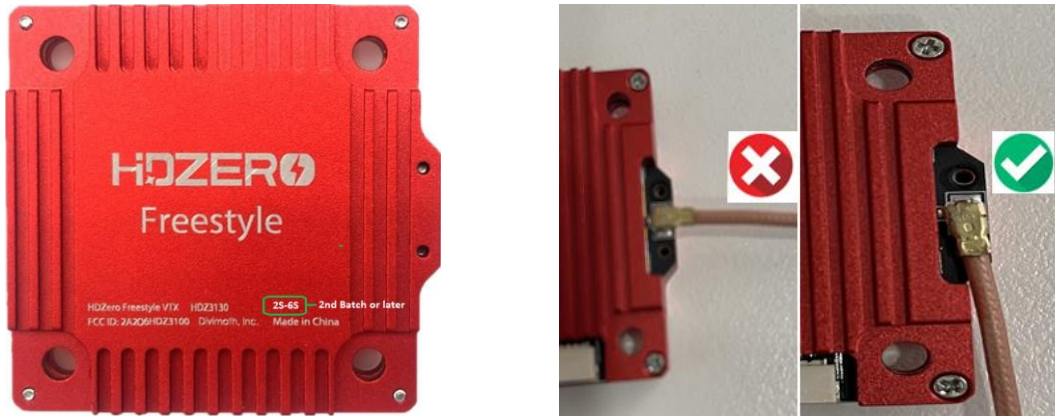

Important Notes:

- Do not directly power this VTX with a 5S/6S battery for the 1st batch.
 - Use 2S-4S VBAT, or included BEC, or FC with built-in BEC
 - The Freestyle VTX consumes up to 15W. If it is connected with FC that has a built-in BEC output, make sure the BEC can provide enough current. For example, if the BEC provides 10V, it needs a minimum of 1.5A current output.
- Removing the heat sink is not recommended because it is part of the design.
- Rotate the antenna as shown above before detaching it to reduce the risk of peeling off the UFL connector.

HDZero Freestyle VTX is compliant with FCC 47 CFR 97.215(c). It is limited to 25mW/200mW out of the box, but it is capable of up to 1W if you have the required HAM radio license to use this power output. Download the special firmware from www.hd-zero.com/document to enable higher RF output modes.

Here are the steps:

1. Download firmware Unlock_FreestyleVTX.zip.
2. Unzip it to the root directory of SD Card.
3. Use the VRX to flash this firmware to the VTX.
4. Power on the VTX, BLUE LED will flash 3 times after it is done. This step unlocks VTX.
5. Power the VTX off.
6. Unzip normal VTX firmware to the root directory of SD Card.
7. Use the VRX to flash this firmware to the VTX.
8. The higher RF output options will now be available.

Please note once the VTX is unlocked, there is no need to unlock it again when there is newer firmware available.

HDZero VTX Installation Guide

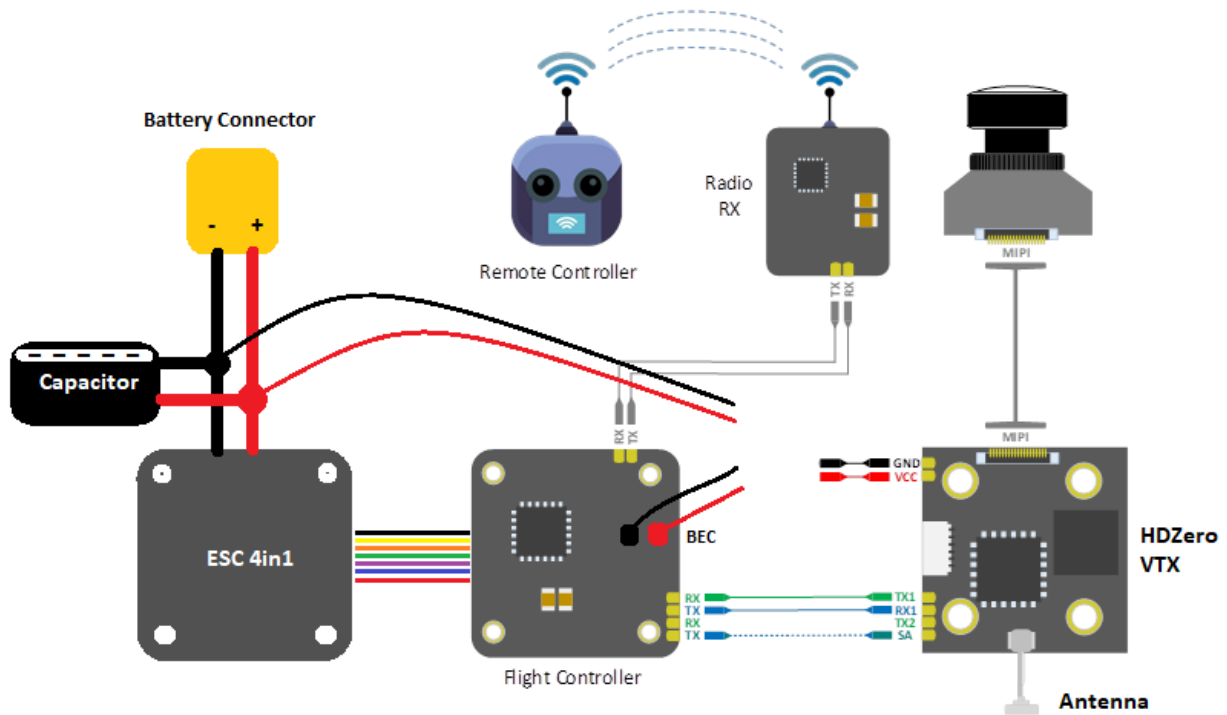

Notes:

- VTX can be powered by VBAT or BEC. Check each VTX's power requirement above;
- Use of capacitor is mandatory for HDZERO VTX;
- One UART is needed for OSD, Camera, VTX menu;
- Never apply power on VTX without antenna installed and secured;
- Use RHCP antennas to match with SharkByte VRX RHCP patch antennas;
- Whoop VTX does not have SA pin, and it does not support SmartAudio.

HDZero Firmware Update Guide

The firmware can be downloaded from www.hd-zero.com/document

Revision(dd/mm/yy)	Download	Release notes	Remark
Rev 26012022	Rev 26012022.zip	1.VRX support diy boot logo. 2.Modified the VTX table	Including ScoutHD
Rev 18122021	Rev 18122021.zip	1.Support Micro V2 Camera. 2.Changed Camera Menu	
Rev 28102021	Rev 28102021.zip	1.Fixed glitchy/frozen OSD issue.	
Rev 20102021	Rev 20102021.zip	1.Camera menu support. 2.Add F2/F4 channel of R1-R8 channels	Including ScoutHD
Rev 23072021	Rev 23072021.zip	1.Supports Canvas mode. 2.New OSD font.	Including ScoutHD/Bytefrost
Rev 15042021	Rev 15042021.zip	1.MSP only	

Note:
 1. TX5S.1/Whoop VTX use the same firmware (TX5S.1.Revxxxxxxx).
 2. TX5R.1/Race V2 VTX use the same firmware (TX5R.1.Revxxxxxxx).

Each revision contains firmware for all the VTX and VRX. And revision number is formatted as *revddmmyyyy.zip* where “*ddmmyyyy*” denotes its release date.

Name	Type	Compressed size	Password ...	Size	Ratio	Date modified
Customize_logo.zip	Compressed (zipped) Fol...	23,215 KB	No	23,215 KB	0%	6/5/2022 3:34 PM
FreestyleVTX.Rev22032022.zip	Compressed (zipped) Fol...	22 KB	No	22 KB	0%	6/5/2022 3:34 PM
HDZeroVRX_4SMA_Rev22032022.zip	Compressed (zipped) Fol...	5,325 KB	No	5,325 KB	0%	6/5/2022 3:34 PM
ScoutHD.Rev22032022.zip	Compressed (zipped) Fol...	5,387 KB	No	5,387 KB	0%	6/5/2022 3:34 PM
SharkByteVRX_2SMA_Rev22032022....	Compressed (zipped) Fol...	5,395 KB	No	5,395 KB	0%	6/5/2022 3:34 PM
TX5M.1.Rev22032022.zip	Compressed (zipped) Fol...	19 KB	No	19 KB	0%	6/5/2022 3:34 PM
Whoop_TX5S.1.Rev22032022.zip	Compressed (zipped) Fol...	20 KB	No	20 KB	0%	6/5/2022 3:34 PM
WhoopLite_Race.Rev22032022.zip	Compressed (zipped) Fol...	22 KB	No	22 KB	0%	6/5/2022 3:34 PM

Products	Firmware
HDZero VRX	HDZeroVRX_4SMA_Revddmmyyyy.zip
HDZero Freestyle VTX	FreestyleVTX.Revddmmyyyy.zip
HDZero Whoop VTX	Whoop_TX5S.1 Revddmmyyyy.zip
HDZero Whoop Lite VTX	WhoopLite_Race.Revddmmyyyy.zip
HDZero Race V1 VTX	WhoopLite_Race.Revddmmyyyy.zip
HDZero Race V2 VTX	WhoopLite_Race.Revddmmyyyy.zip
Shark Byte TX5S.1	Whoop_TX5S.1 Revddmmyyyy.zip
Shark Byte TX5M.1	TX5M.1.Revddmmyyyy.zip
Shark Byte TX5R.1	WhoopLite_Race.Revddmmyyyy.zip
Shark Byte RX.1	SharkByteVRX_2SMA_Revddmmyyyy.zip
Shark Byte ScoutHD	ScoutHD.Revddmmyyyy.zip

VTX update Guide

All the zip file for each VTX contains HDZERO_TX.bin.

Steps to update VTX firmware:

- (1) Format SD card (Choose FAT32 and Allocation Unit size to 4096 bytes);
- (2) Power off VRX if it is on;
- (3) Unzip content of corresponding VTX zip file onto SD-card, and insert SD to the VRX module;
- (4) Connect cable with module and VTX as shown right;
- (5) Power on VRX module
- (6) If “Wait to Connect VTX...” or “Check cable ...”, make sure (4) is secured;
- (7) If “Firmware update failed”, Repeat steps from (1);
- (8) If “Firmware update successful”, VTX is updated.
- (9) HDZERO_TX.bin is removed from SD card automatically.

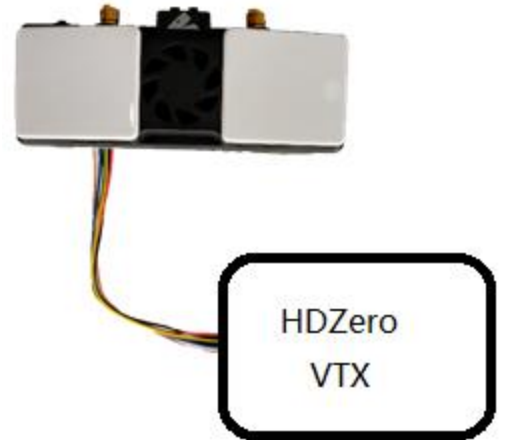

Note: Putting an empty file named as “DONOTREMOVE.txt” file on SD card root directory will prevent HDZERO_TX.bin from being removed. It is useful when updating multiple VTXes.

VRX update Guide

Steps to update HDZero VRX

- (1) Disconnect the cable connecting VRX and VTX, if it is connected;
- (2) Unzip content of HDZeroVRX_4SMA_Revddmmyyyy.zip onto SD-card, insert SD to the module
- (3) Power on VRX, and waiting for “Success”.

Steps to update Shark Byte VRX

- (1) Disconnect the cable connecting VRX and VTX, if it is connected;
- (2) Unzip content of SharkByteVRX_2SMA_Revddmmyyyy.zip onto SD-card, insert SD to the module
- (3) Power on VRX, and waiting for “Success”.

The firmware will be automatically deleted from SD card after updating.

Note: Do not power off VRX while updating firmware until “Update Completed”. Otherwise VRX will not be able to boot up next time.

Steps to flush VRX in case of not booting up

- (1) Power off VRX;
- (2) Unzip content of the file below onto SD-card, insert SD to the module;
 - a. - HDZeroVRX_4SMA_Revddmmyyyy.zip for HDZero VRX, or
 - b. - SharkByteVRX_2SMA_Revddmmyyyy.zip for Shark Byte VRX
- (3) Move the switch to Bottom position with tweezers (not included);

- (4) Power on goggle module, the red LED will be lit;
- (5) Wait for red LED to turn off, on, and then off again (it may take over 10 min to complete);
- (6) Power off, and move the switch to TOP position with tweezers;
- (7) Repower goggle module, it should now boot up normally.

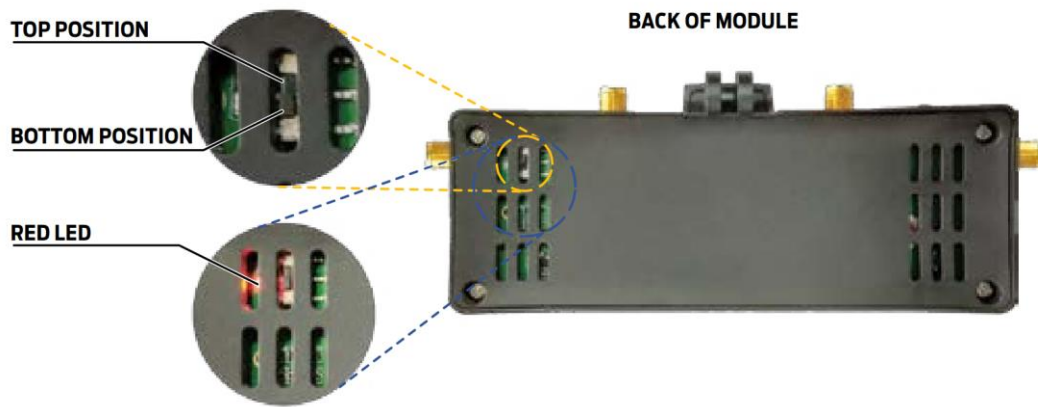

Setup and Getting Started

OSD Setup

1. Prerequisite

- Betaflight >= 4.2.8
- Inav >= 4.1
- FlightOne >= 10.1.1.5576 | 10.1 Alpha 29

2. Update firmware VTX and VRX

- Download the latest firmware: www.hd-zero.com/document
- Firmware package (Rev_ddmmyyy.zip) contains the firmware for all the VTX and VRX

3. Solder/Connect VTX UART to an available UART on your FC board

see installation diagram above

4. Flight controller Configuration (Use Betaflight as example)

- Connect the FC board to computer with an USB cable
- Start Betaflight configurator
- Go to Port TAB
- Activate MSP protocol with 115200 baud-rate on UART number that is used to connect the VTX
- If you have connected the SA pad to your FC, to use SmartAudio functionalities, activate the Smartaudio protocol on the UART number you used to connect the SA pad.
- **Save and Reboot**

Note

- A soft serial UART is **not** supported for MSP protocol.
- **Not** all UART ports of FC support SmartAudio, check the FC user manual first.

As an example: UART5 on picture below is used for MSP, and UART3 is used for Smartaudio

Ports

Note: not all combinations are valid. When the flight controller firmware detects this the serial port configuration will be reset.
Note: Do NOT disable MSP on the first serial port unless you know what you are doing. You may have to reflash and erase your configuration if you do.

Identifier	Configuration/MSP	Serial Rx	Telemetry Output	Sensor Input	Peripherals
USB VCP	<input checked="" type="checkbox"/> 115200 ▾	<input type="checkbox"/>	Disabled ▾ AUTO ▾	Disabled ▾ AUTO ▾	Disabled ▾ AUTO ▾
UART1	<input type="checkbox"/> 115200 ▾	<input type="checkbox"/>	Disabled ▾ AUTO ▾	Disabled ▾ AUTO ▾	Disabled ▾ AUTO ▾
UART2	<input type="checkbox"/> 115200 ▾	<input type="checkbox"/>	Disabled ▾ AUTO ▾	Disabled ▾ AUTO ▾	Disabled ▾ AUTO ▾
UART3	<input type="checkbox"/> 115200 ▾	<input type="checkbox"/>	Disabled ▾ AUTO ▾	Disabled ▾ AUTO ▾	VTX (TBS Sm: ▾ AUTO ▾
UART4	<input type="checkbox"/> 115200 ▾	<input checked="" type="checkbox"/>	Disabled ▾ AUTO ▾	Disabled ▾ AUTO ▾	Disabled ▾ AUTO ▾
UART5	<input checked="" type="checkbox"/> 115200 ▾	<input type="checkbox"/>	Disabled ▾ AUTO ▾	Disabled ▾ AUTO ▾	Disabled ▾ AUTO ▾

5. Restart/Connect Flight controller Configuration (Use Betaflight as example)

- Go to configuration tab
- Activate OSD function
- Activate Telemetry function

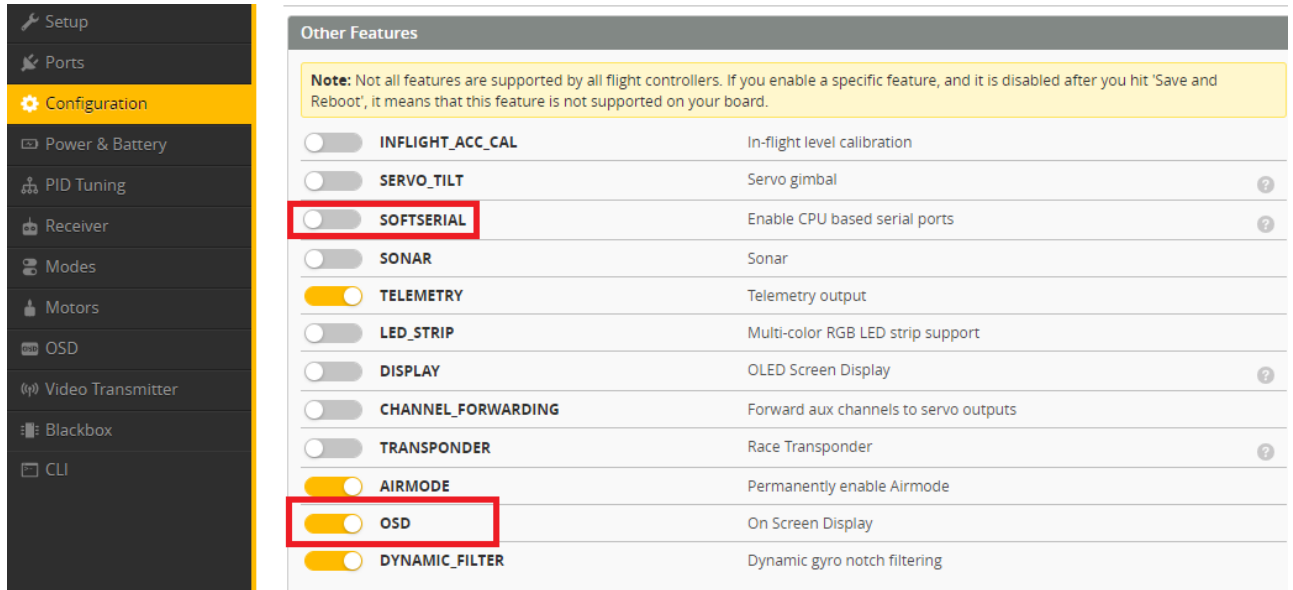

- SAVE
- Go to OSD tab, and configure the items you want to show on your screen
- SAVE
- Go to CLI tab to enable MSP Display Port
set osd_displayport_device = MSP
set displayport_msp_serial = YOUR_UART_PORT_NUMBER - 1
save

In our example, we used UART5 for MSP Connection (UART5 - 1 = 4) , we will enter this :

```
set osd_displayport_device = MSP
set displayport_msp_serial = 4
save
```

Stick Movement

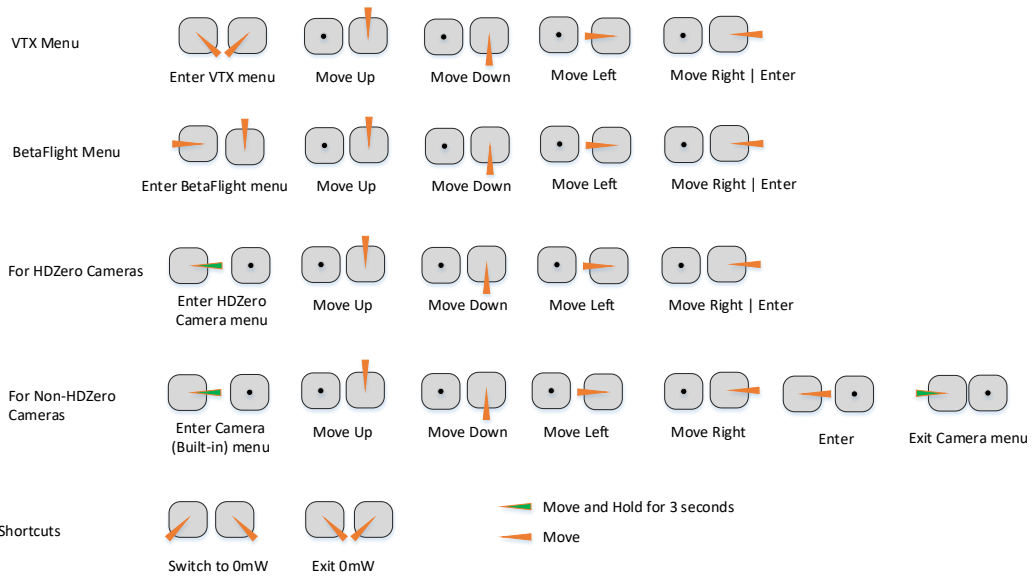

Using VTX Menu (Applicable to all HDZero VTXes)

VTX menu will be available when

- The VTX does not support SmartAudio, or
- VTX.SA pin is **not** physically connected with FC, or
- VTX.SA pin is connected but the related UART port of FC is disabled.

All HDZero VTXs have the following settings for its RF power level management. These settings can be changed using the VTX menu.

POWER: The desired RF power level is selectable between 25mW, 200mW (and 500mW or MAX for certain VTXes). The actual RF power level depends on the following settings and FC status.

PIT_MODE: The three modes of this setting are:

- **P1MW:** The output RF power will be 0.1mW (in order to not interfere with other pilots) in this mode. If the quad is armed, RF output power will be automatically set to the *POWER* within seconds.
- **0MW:** There will be zero RF output in this mode. If quad is armed, RF output power will be automatically set to *POWER* within seconds.
- **OFF:** The output RF power will be set to *POWER* setting.
(Note that after first arm, the vtx will not enter pitmode again until vbat power is reset)

LP_MODE:

- **ON:** If *PIT_MODE* is OFF and the quad is disarmed, the RF power level will be forced to 25mW regardless of *POWER* setting. The output RF power will be set to *POWER* setting when quad is armed.
- **OFF:** The output RF power will be set to *POWER* setting.

OFFSET_25MW: It is to fine tune the RF output power to be exactly 25mW. The range is [-10:10], and step size is about 0.3dB per step.

Notes:

- HDZero VTX will still become hot even on P1mW mode. It is better to keep VTX on PIT 0mW mode when it will be idle for a while. Though the receiver will not have live video on this mode, it will come back as soon as the quad is armed.
- Use sticks shortcut to enter 0mW, and to exit 0mW mode.



Using SmartAudio (Not applicable to HDZero Whoop VTX)

HDZero Race VTX can be controlled by FC using the TBS SmartAudio V2.1. In this case, the VTX will output RF power and channel commanded by FC directly. To avoid conflict, the VTX menu is not available if SmartAudio is enabled.

Notes:

- HDZero Race VTX outputs 0.1mW when SmartAudio PIT mode is ON.
- HDZero Race VTX does not support SmartAudio out range PIT mode.
- When HDZero Race VTX boots up, it will automatically detect the existence of a valid SmartAudio link with FC within 10 seconds. If the link exists, FC will fully control race VTX's RF output power and working frequency.

VTX table needs to be set as below. Please note that HDZero Race VTX supports all 8 channels (R1 ~ R8) on R band, and 2 channels (F2 and F4) on F band.

The screenshot shows the VTX configuration interface. The 'Selected Mode' section includes a toggle for 'Enter frequency directly', a dropdown for 'RACEBAND' (Band), a dropdown for 'Channel 1' (Channel), a dropdown for '25' (Power), a toggle for 'Pit Mode', a dropdown for '0' (Pit Mode frequency), and a dropdown for 'Off' (Low Power Disarm). The 'VTX Table' section shows '6' bands and '8' channels by band. The table lists bands 1 through 6 with their respective names, letters, factory settings, and frequency values. The 'Number of power levels' is set to 3, with values 14, 23, and 0, and labels 25, 200, and 0.

Name	Letter	Factory	1	2	3	4	5	6	7	8	
BOSCAM_A	A	0	0	0	0	0	0	0	0	0	Band 1
BOSCAM_B	B	0	0	0	0	0	0	0	0	0	Band 2
BOSCAM_E	E	0	0	0	0	0	0	0	0	0	Band 3
FATSHARK	F	0	5760	0	5800	0	0	0	0	0	Band 4
RACEBAND	R	5658	5695	5732	5769	5806	5843	5880	5917		Band 5
IMD6	I	0	0	0	0	0	0	0	0	0	Band 6

The above setting can also be done with the following CLI commands:

```

vtxtable bands 6
vtxtable channels 8
vtxtable band 1 BOSCAM_A A FACTORY 0 0 0 0 0 0 0
vtxtable band 2 BOSCAM_B B FACTORY 0 0 0 0 0 0 0
vtxtable band 3 BOSCAM_E E FACTORY 0 0 0 0 0 0 0
vtxtable band 4 FATSHARK F FACTORY 0 5760 0 5800 0 0 0 0
vtxtable band 5 RACEBAND R FACTORY 5658 5695 5732 5769 5806 5843 5880 5917
vtxtable band 6 IMD6 I FACTORY 0 0 0 0 0 0 0
vtxtable powerlevels 3
vtxtable powervalues 14 23 0
vtxtable powerlabels 25 200 0

save

```

With SmartAudio, the user can change channel number and power level even when quad is in the air.

Example 1: Map a 3-phase button (aux channel 3) to 3 different RF power levels (25mW, 200mW, and 0mW).

VTX	<index>	<aux_channel>	<vtx_band>	<vtx_channel>	<vtx_power>	<start_range>	<end_range>
vtx	0	2	0	0	1	900	1300
vtx	1	2	0	0	2	1300	1700
vtx	2	2	0	0	3	1700	2100
		(aux ch -1)	0 means no change				

```
vtx 0 2 0 0 1 900 1300
vtx 1 2 0 0 2 1300 1700
vtx 2 2 0 0 3 1700 2100
save
```

Example 2: Map a 3-phase button (aux channel 4) to Channel R1, R2 and F2.

VTX	<index>	<aux_channel>	<vtx_band>	<vtx_channel>	<vtx_power>	<start_range>	<end_range>
vtx	3	3	5	1	0	900	1300
vtx	4	3	5	2	0	1300	1700
vtx	5	3	4	2	0	1700	2100
					0=no change		

```
vtx 3 3 5 1 0 900 1300
vtx 4 3 5 2 0 1300 1700
vtx 5 3 4 2 0 1700 2100
save
```

3 different RF power levels are specified on the above table. #1 and #2 specify 25 mW and 200mW RF power respectively, and #3 is to turn off RF output completely.

HDZero Race VTX will become very hot if it is on the bench without airflow, even if it is on 25mW or PIT mode. It is recommended to put VTX on 0mW while quad is waiting on the line.

When #3 is selected from SmartAudio menu by mistake, the receiver will lose video feed since VTX is not transmitting. Use stick command  to exit 0mW mode.

Help and Troubleshooting

FAQ

1	Facebook Group and Discord Server?	www.facebook.com/groups/HDZero https://discord.gg/JPesSHpmCU
2	Does VRX have low voltage alarm?	VRX does not have low voltage alarm. We recommend using an in-line battery alarm (not included) between the battery and DC cable
3	How does VRX power cable work?	DC cable has integrated DC regulator which converts from 3S-6S to fixed 7.8V output. (Manual says 3S-4S) It is very important to unplug DC cable from battery after flight. Otherwise, DC cable will suck up battery power and cause permanent damage to battery.

Trouble Shooting

1	Video feed is working but no OSD	<p>(a) VTX/VRX Firmware mismatch: Update both VTX and VRX from the same firmware release.</p> <p>(b) Wire connection: TX and RX of FC board should be connected with RX and TX pads of VTX respectively.</p> <p>(c) Betaflight setting: Instruction on Page 10/11 on Shark Byte User Manuel 08042021.pdf</p> <ul style="list-style-type: none">- Betaflight 4.2.8 or above- CLI commands <pre>set osd_displayport_device = MSP set displayport_msp_serial = n-1//n= serial port number minus 1 save get displayport_msp_serial //to verify the value previously set</pre> <p>(d) Try another UART port of FC (avoid to use soft-serial and SA ports)</p>
2	No Blue LED on VTX	<p>From Firmware Rev30092021, Blue LED works as the following way:</p> <ol style="list-style-type: none">(1) Flashing at 1Hz periodically if *no* camera is found after VTX is powered up(2) Flashing 8 times if MSP connection is established with FC after VTX is powered up(3) Remains OFF for HDZero Micro Camera(Beta), ON for all other cameras. <p>If a Non beta HDZero Micro camera is attached, and get NO blue LED, please</p> <ol style="list-style-type: none">(a) Check if MIPI cable is secured on both end of camera and VTX, and check if cable itself is fine(b) Carefully check VTX MIPI connector if there is any bent pin(c) If it is Foxeer Digisight Camera, make sure it is NOT on analog mode<ul style="list-style-type: none">- Digisight goes to analog when pressing left for 3 sec- Use stick commands blindly or disconnect mipi and use external joystick.

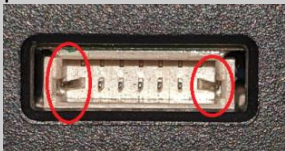
		<p>- Joystick does not work in digital mode. Must use stick commands (Thr mid, yaw right) to enter cam menu (BF OSD disappears)</p> <p>(d) If it is Micro HDZero camera, it needs firmware that is released after June 23 2021</p>
3	Snow noise even in short distance	<p>(a) Add a big capacitor (350+ uF 50V) in parallel to battery leads to smooth the power supply of the whole quad</p> <p>(b) Move Radio RX and its antenna away from VTX</p> <p>(c) Do not place VTX next to ESC board</p> <p>(d) Try another pigtail (if there is)</p> <p>(e) Try another antenna</p> <p>(f) Ensure U.FL connector of VTX has at least 7mm vertical clearance</p> <p>(g) Check if there is other VTX (analog, DJI, HDZero) working on current channel</p> <p>(h) Check if there is WIFI interference</p>
4	Recording files are zero byte length	<p>There are two recording file format: TS and MOV format</p> <p>On TS format, VRX ensures video will be recorded until last second before VRX is powered off.</p> <p>On MOV format, VRX will not have enough time to close the recorded file if VRX is powered off. Therefore, it is important to manually close the file by switching to setting mode (Long press Left key) or switching channel (press Right key) before powered down VRX</p>
5	SD card not working	<p>(a) An 8G-32G SD card Recommended</p> <p>(b) Format SD card before using:</p> <ul style="list-style-type: none"> - Use VRX to format SD card - Use Windows to format (Choose FAT32 and Allocation Unit size to 4096 bytes)
6	No Red LED	<p>(a) Make sure input voltage is 7V-26V</p> <p>(b) The VTX consumes about 5W, make sure power source has enough max current</p>
7	Why is chan/band/power displayed as ???	<p>When you are not using Smart Audio some information is no longer passed through to the MSP port by Betaflight.</p> <p>In this instance you need to select an unused UART and enable in the peripherals VTX(TBS SmartAudio)</p> <p>Next set up the VTX table as per setting up Smart Audio section</p>
8	Flashing VTX fails	<p>Check if any pins on VRX or VTX update port are bent. Pins should all be straight. Example of crooked pin on the VRX causing flashing problems:</p> 
9	FC dropping to bootloader	<p>Add a 200ohm resistor between the wire from FC UART.TX to VTX UART.RX</p>